

Optional Article

Mounting instruction

TABLE OF CONTENTS

1. Safety instruction	3
2. Installation of grounding connector	5
2.1. Grounding connector – flat roof.....	5
2.2. Grounding connector – pitched roof.....	6
2.3. Grounding connector – C-rail	7
2.4. Grounding connector - C-N-rail	8
3. Assembling jig	9
4. Mounting-Set Optimizer	10
4.1. Mounting-Set Optimizer – flat roof.....	10
4.2. Mounting-Set Optimizer – pitched roof.....	11
5. End cap C-rail C47 / C38 black	12
6. Top cover C- rail / C-N-rail	13
7. Contact latch insertion rail	14
8. Aluminium edge protector self-adhesive	15
9. Base trough cabel bracket	16
10. Angled base trough connector 150-30 3°	17
11. Top cover base trough 150-30	18
12. Support rail IR	19
13. Shim for roof hook PP grey, 2mm/5mm	20
14. Shim for roof hook ZD 30 N35, 2mm/5mm	21

1. Safety instruction

The following instructions are to be understood as generally valid for our novotegra installation system and are to be applied accordingly, regardless of the particular roof type and installation system.

Systems may only be installed and commissioned by persons who are able to ensure that they are carried out in accordance with the regulations on the basis of their professional qualifications (e.g. training or activity) or experience.

All relevant national and locally applicable occupational health and safety regulations, accident prevention regulations, standards, construction regulations and environmental protection regulations as well as all regulations of the employers' liability insurance associations must be observed.

- During the work, safety clothing must be worn in accordance with the relevant national regulations and guidelines.
- The assembly must be carried out by at least two persons in order to be able to guarantee help in case of an accident.
- The national regulations for work at heights and on roofs must be observed.
- The electrical work must be carried out in compliance with the national and locally applicable standards and guidelines in compliance with the safety regulations for electrical work.

The installer is responsible for dimensioning the novotegra mounting system.

Before installation, it must be checked whether the mounting system meets the static requirements on site for roof systems, the on-site load-bearing capacity of the roof must also be checked. Please note our instructions on static calculations, which can be viewed at novotegra.com/downloads.

The installer is responsible for connecting the interfaces between the mounting system and the building. This also includes the tightness of the building envelope. The mounting system must always be statically calculated individually for each project using the Solar-Planit design software. Except for facade systems on concrete, the calculation for this is carried out by novotegra GmbH.

The mounting system is suitable for mounting PV modules with standard market dimensions. The installation instructions of the module manufacturers must be observed and complied with. There is no inspection by novotegra GmbH regarding constructability or mounting guidelines.

The specifications of the cable and inverter manufacturers must be observed. If there are any contradictions to these installation instructions, please be sure to consult your novotegra GmbH sales team or - in the case of components not supplied by novotegra GmbH - the manufacturer concerned before installing the novotegra mounting system.

It must be ensured that a copy of the assembly instructions is within reach in the immediate vicinity of the work on the construction site.

Since our assembly systems are constantly being further developed, assembly procedures or components may change. Therefore, please check the current status of the installation instructions on our website novotegra.com/downloads/ before installation. The assembly sequence of these instructions must be observed. We will also be happy to send you current versions on request.

In the event of improper use and non-compliance with our safety instructions and installation specifications, as well as non-use of associated installation components or use of third-party components that are not part of the installation system, all claims under guarantee, warranty and liability vis-à-vis novotegra GmbH shall

lapse. The user is liable for damage and resulting consequential damage to other components such as PV modules or to the building itself, as well as for personal injury.

The permissible roof pitch for the use of the mounting system in accordance with these installation instructions is 0 to 60 degrees for installation parallel to the roof on a pitched roof and 0 to 5 degrees for elevated installation on a flat roof. Facade systems are to be mounted parallel to the facade.

The grounding / potential equalization of the mounting system must be carried out in accordance with the national and locally applicable standards and guidelines.

If all safety instructions are observed and the system is installed properly, there is a product warranty claim of 12 years. Please note our warranty conditions, which can be viewed at novotegra.com/downloads.

The system can be dismantled in reverse order to the steps described below.

2. Installation of grounding connector

2.1. Grounding connector – flat roof



Grounding connector C-rail – Flat roof

Grounding connector C- rail for clamping cables of 6-16 mm² or wire with diameter 6-10 mm.

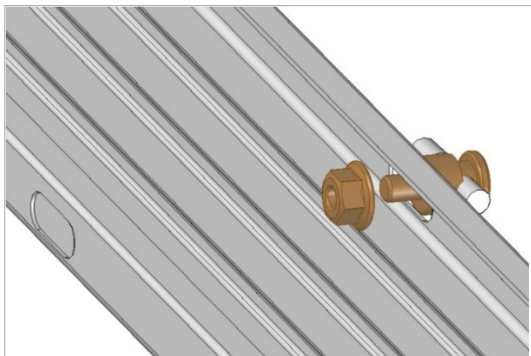

The grounding connector must be mounted in the drainage hole of the base trough. A torque spanner must be used for installation.

Tightening torque 20Nm.

One grounding connector must be fitted per module field.

2.2. Grounding connector – pitched roof



Grounding connector C-rail

Grounding connector C- rail for clamping cables of 6-16 mm² or wire with diameter 6-10 mm.

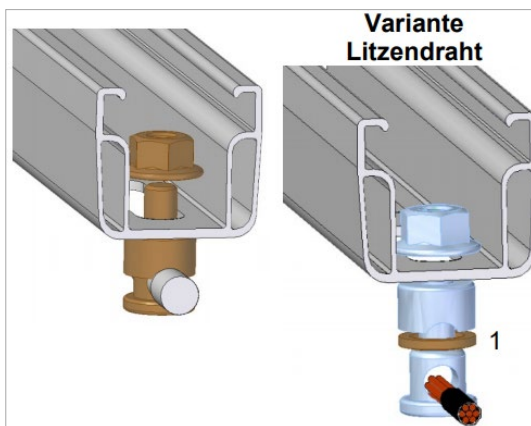

Place the grounding connector in the slots of the C-rail and fit it. A torque spanner must be used for installation.

Tightening torque 20Nm.

One grounding connector must be fitted per module field.

2.3. Grounding connector – C-rail



Grounding connector C-rail

Grounding connector C- rail for clamping cables of 6-16 mm² or wire with diameter 6-10 mm.



Place the grounding connector in the slots of the C-rail and fit it. A torque spanner must be used for installation.

Tightening torque 20Nm.

One grounding connector must be fitted per module field.



The picture on the left shows the fully assembled grounding connector on a C 47 rail.

2.4. Grounding connector C-N-rail



Grounding connector C-N-rail

Grounding connector C-N- rail for clamping cables of 6-16 mm² or wire with diameter 6-10 mm.



The groove screw of the grounding connector must be screwed into the side groove of the C-N rail. Then insert the earthing wire or earthing cable and tighten the grounding connector. A torque spanner must be used for assembly.

Tightening torque 20Nm.

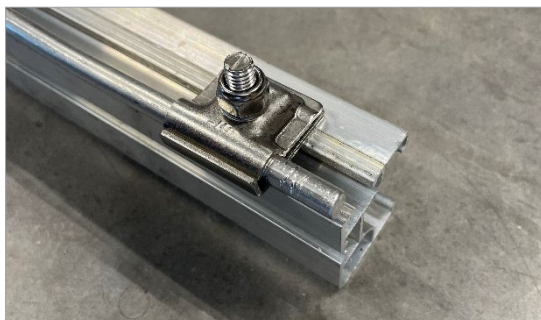

The picture on the left shows the fully screwed grounding connector on the C-N rail C37.

novo-tip: The installation of the grounding connector on the C-N rail C-N 60 works in the same way.

3. Assembling jig



Assembling jig.

The mounting jig, which are matched to the novotegra mounting system, consist of two square tubes. The square tubes can be pushed apart or together using the rotary knob. The mounting jig serves as a dummy to make it easier to measure in the modules.

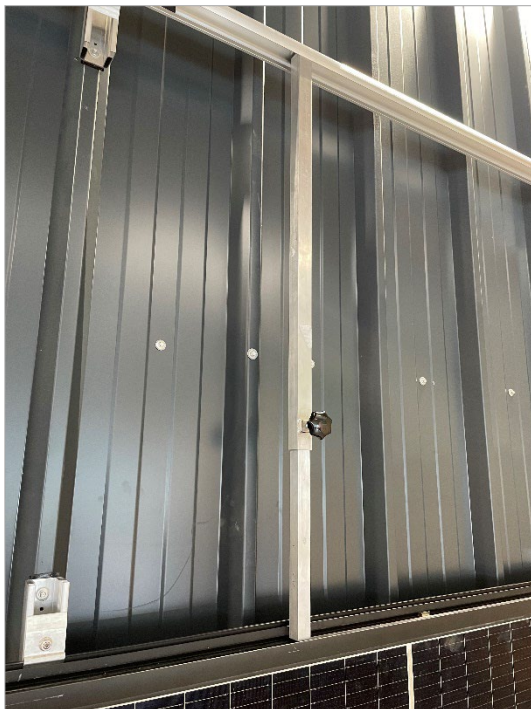

Set the mounting jig to the required module length or module width. Then place the mounting jig between the rails and align the rails using the mounting jig.

The picture on the left shows the use of the mounting jig in combination with the insertion rail on the sheet metal facade.

4. Mounting-Set Optimizer

4.1. Mounting-Set Optimizer – flat roof

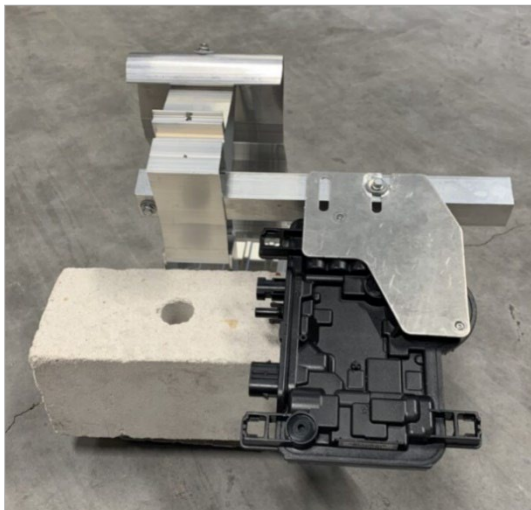
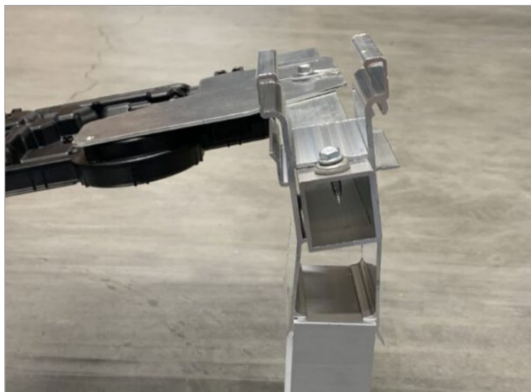

Mounting-Set Optimizer FR

The mounting-set optimizer FR consists of a square tube and thin sheet screws AF 8 hexagon drive. A cordless screwdriver with hexagon head is used for installation.

The square tube is inserted into the hole provided in the module support.

The square tube is fastened with screw that is fixed into the tube.

Warning: The screw must not be overtightened! Do not use an impact function when tightening the screws.

Use the second screw to fix the power optimizer onto the square tube.

The square tube cannot slip out of the support as the screw on one side and the optimizer on the other prevent this.

Warning: The screw must not be overtightened! Do not use an impact function when tightening the screws.

4.2. Mounting-Set Optimizer – pitched roof



Mounting-Set C Rail M8

The mounting set C M8 is used to fasten components such as power optimizers to the C-rail. It consists of a locking nut M8 AF 18 as well as a rail nut and a 50x50x3 mm aluminium plate D 8.5 mm.

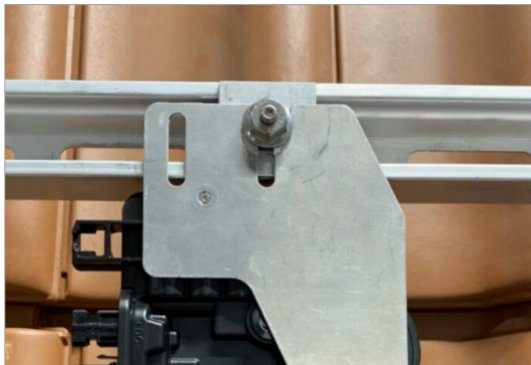

The rail nut is screwed into the C-rail. Then the plate is fitted. The optimizer must be screwed onto the rail nut using the locking nut.

Tightening torque 25 Nm.

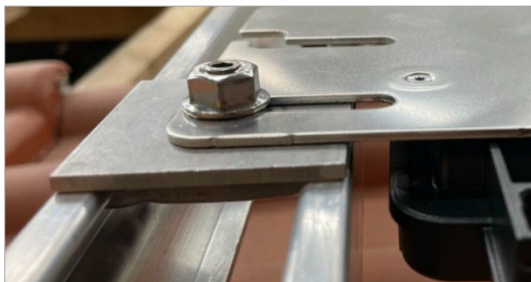

The picture on the left shows the fully assembled mounting set C M8 on a C-rail.

5. End cap C-rail C47 / C38 black

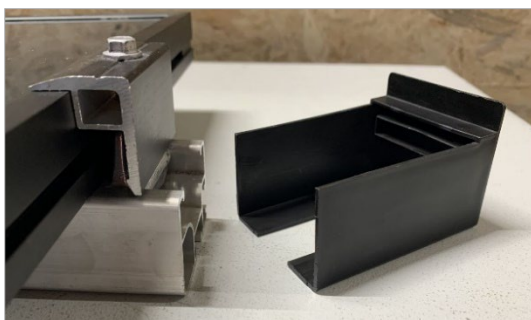

End cap C-rail C47 / C38

The end cap provides a clean finish at the edge of the system.

If the end cap is fitted, the C-rail must be left 1 cm longer. This is not currently taken into the Solar-Planit and must be added when sawing the rails.

The end cap is pushed onto the end of the C-rail and fixed in place by tightening the end clamp.

The picture on the left shows the fully assembled end cap for the C-rail.

novo-tip: The end cap for the C-N rail C 37 is fitted in the same way. To fit the end cap, 1 cm must also be added to the C-N rail when cutting to length.

6. Top cover C- rail / C-N-rail



Top cover C- / C-N-rail

The top cover serves as a cover to click into place when using the C- or C-N rail as a cable channel.



The top cover is placed on the channel of the C- or C-N- rail. It can be easily clicked into place by pressing on the cover.



The top cover must snap into place and should not have any play. Additional tightening is not necessary.

7. Contact latch insertion rail

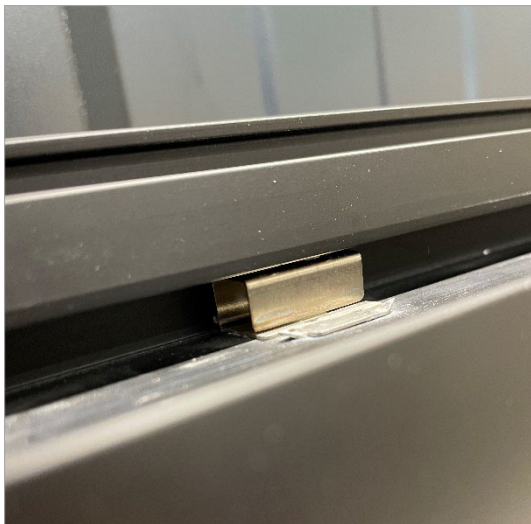
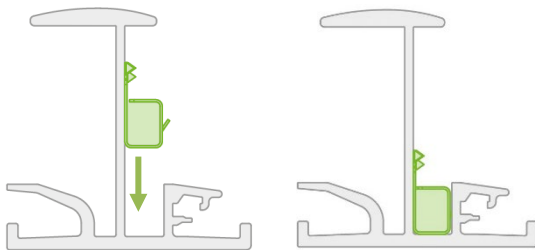
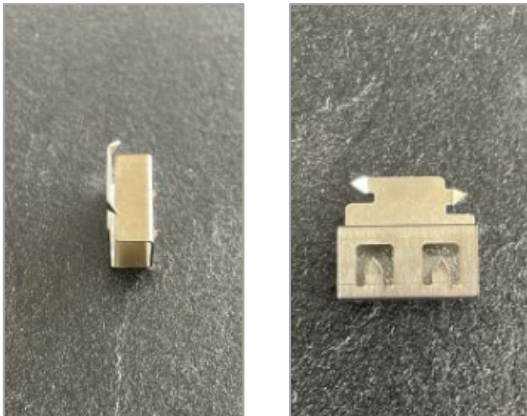

Contact latch insertion rail

The contact latch for all insertion rails from the novotegra portfolio is used to ensure potential equalisation between the module and insertion rail.

The contact latch must be pressed into the groove of the insertion rail by hand (see picture on the left). The teeth of the contact latch realise the contact with the black anodised aluminium of the module frame.

The contact latch must be firmly seated in the rail. The module can now be placed in the insertion rail. One contact latch must be placed per module.

8. Aluminium edge protector self-adhesive



Aluminium edge protection

The roof cladding must be protected from sharp edges. The aluminium edge protection self-adhesive must be glued to the edges of all base troughs, all cut rails and all edges of the expansion joint.



To apply the aluminium edge protection, remove the self-adhesive aluminium part from the adhesive strip and stick it halfway onto the end of the rail. The adhesive protrusions are folded inwards and pressed down firmly.

The picture on the left shows a precisely bonded aluminium edge protector self-adhesive.

9. Base trough cable bracket



Base trough cable bracket

The base trough cable bracket is used to secure the module and solar cables in the base trough of the flat roof II system:

Base trough 150-30

Base trough 150-30 w/ protection layer and

Base trough 150-30 w/ cross drainage.



The cable bracket is clicked into the base trough with a rotary movement.



If the cable bracket is installed correctly, it lies horizontally in the base trough with the opening facing upwards.

10. Angled base trough connector 150-30 3°



Angled base trough connector 150-30 3°

The Angled base trough connector 150-30 is used to connect two base rails via the ridge or valley of a flat roof. Two connectors and four sheet metal screws AF 8 are used for this purpose.



The angled base trough connector 150-30 must be pushed into the flange of the base trough. After push in the second connector on the opposite side. The second rail piece must then be pushed on.



If the connectors are in the base trough, they must be screwed tight with four sheet metal screws.

Warning: The screw must not be overtightened! Do not use an impact function when tightening the screws.

11. Top cover base trough 150-30

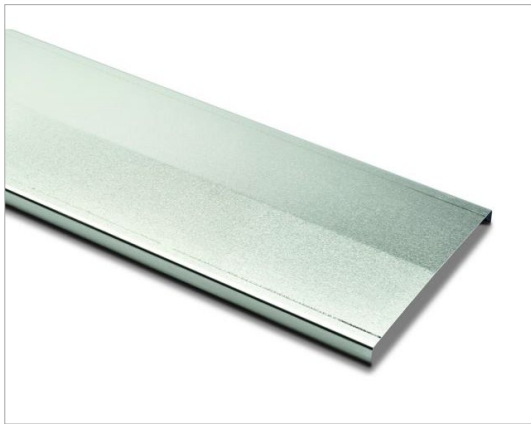

Top cover base trough 150-30

The top cover base trough protects against animal bites and water ingress. It serves as a cover for the base rails of the Flat Roof II system:

Base trough 150-30

Base trough 150-30 w/protection layer and

Base trough 150-30 w/cross drainage.

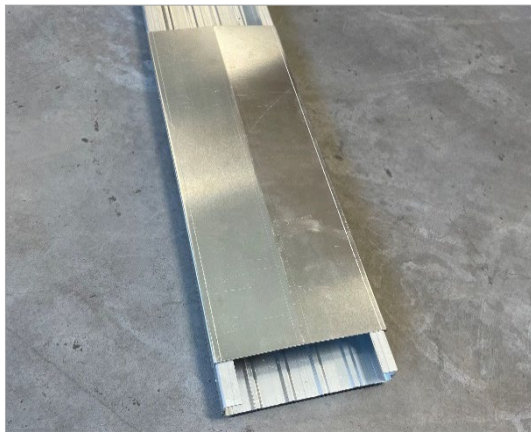

The top cover base trough must be placed on the base trough and can be slid into position.



The top cover base trough must be screwed tight with sheet metal screws SW8. If the rail is used as a cable channel, the cable bracket (see step 7) must be inserted before the cover is fitted. The number of the screws per cover must be in proportion to the rail length.

Warning: The screw must not be overtightened!
Do not use an impact function when tightening the screws

12. Support rail IR



Support rail IR

The support rail IR serves as a module support between the insertion rails of a module row. It must be used for portrait module installation with high snow loads. The module manufacturer's approvals must be observed.

www.novotegra.com/en/mounting-systems/module-approvals

The support rail IR is placed horizontally on the vertical C-rail and fastened with the cross rail connector set C IR M8.

Tightening torque 25Nm.

The support rail IR must be protected against twisting. To do this, the cross rail connector must be mounted alternately at the top and bottom of the C-rail. Comparable to the shape of the letter W.

13. Shim for roof hook PP grey, 2mm/5mm



Shim for roof hook PP grey

The shim plate is used to level out the height of the ZD 533, ZD 544 and ZD 633 roof hooks for side-fix installation.

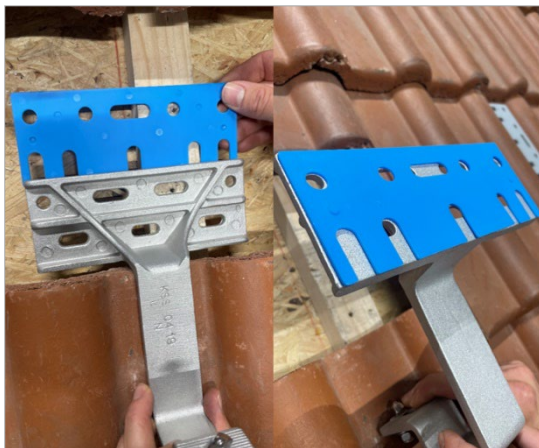

The shim for roof hooks must be positioned precisely under the base profile of the roof hook.

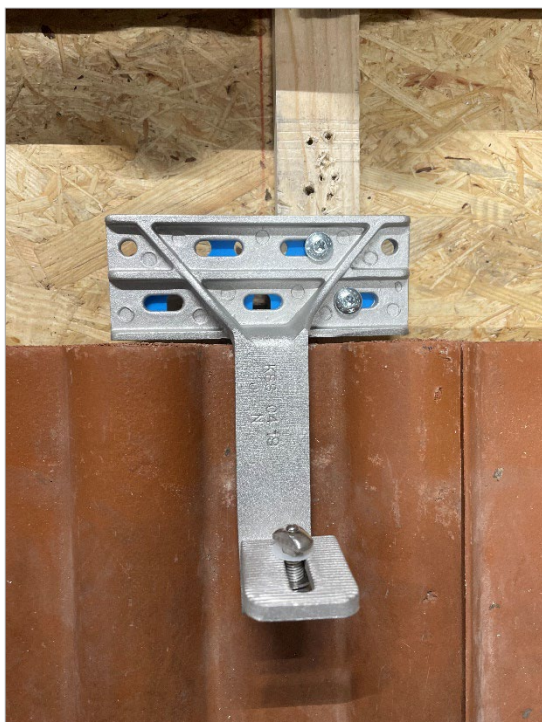

The roof hook must be fastened to the rafter with two screws.

14. Shim for roof hook ZD 30 N35, 2mm/5mm

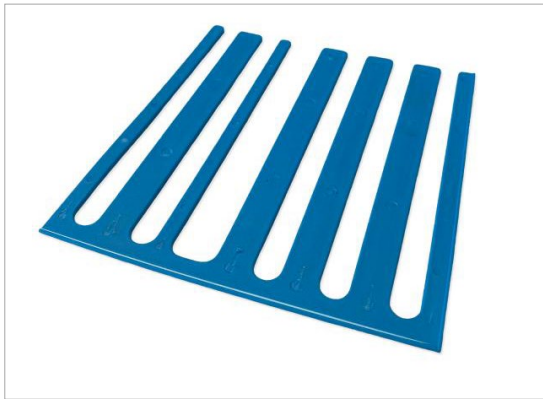

Shim for roof hook ZD 30 N35, 2mm

The shim for roof hooks is used for height levelling for all roof hooks from the novotegra portfolio.

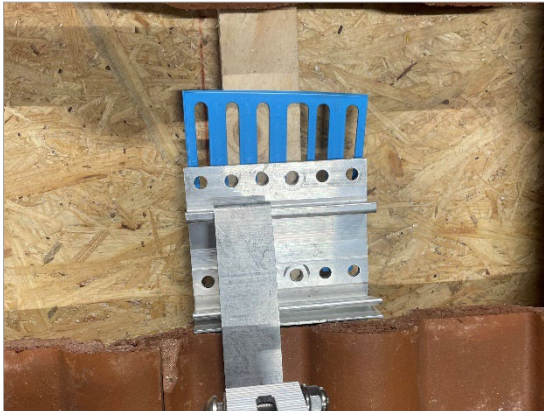

The shim for roof hooks must be positioned precisely under the base profile of the roof hook.



The roof hook must be fastened to the rafter with two screws. The shim plate is flush with the base profile of the roof hook.



novotegra

novotegra GmbH

Eisenbahnstraße 150
72072 Tübingen | Deutschland

Tel. +49 7071 98987-0
Fax +49 7071 98987-10

info@novotegra.com
www.novotegra.com

